

Senior Design Project

EEC 134B Winter 18'

Team: Notorious ENG Final Report

Connor Bard
College of Electrical and
Computer Engineering
UC Davis
Davis, CA
ccbard@ucdavis.edu

Jacob Gonzalez
College of Electrical and
Computer Engineering
UC Davis
Davis, CA
jamgonzalez@ucdavis.edu

Hannah Harter
College of Electrical and
Computer Engineering
UC Davis
Davis, CA
heharter@ucdavis.edu

Mitchell Roberts
College of Electrical and
Computer Engineering
UC Davis
Davis, CA
mhroberts@ucdavis.edu

I. INTRODUCTION

In modern society, it is the electrical engineer's job to pursue new technologies that push scientific discovery and improve the life of all citizens; in this document our team of electrical engineers, aka Notorious ENG, will describe our design of a short range RF radar system, and the results of a subsequent competition. Our design document includes a system block diagram which describes major circuit components, a list of expected system performance characteristics, calculations of system specifications, a budget outline, and additional design details. The design process was a continuous one. At each stage we perfected individual aspects of the system, and collaborated to create a more efficient and functional final product. We followed a schedule throughout the project, to indicate design deadlines and benchmarks we achieved.

As we head into the end of our undergraduate education, the experience culminates with our senior design project. For our project we chose to pursue the design and assembly of a wireless communications RADAR system. An image of our system's block diagram is shown in Figure 1.

In general, there are many applications of Radar technology. Often engineers define the radar system by the approximate distance or "Range" of an object from the transmitter. Typically, we generalize three scenarios, short, medium, and long range radar.

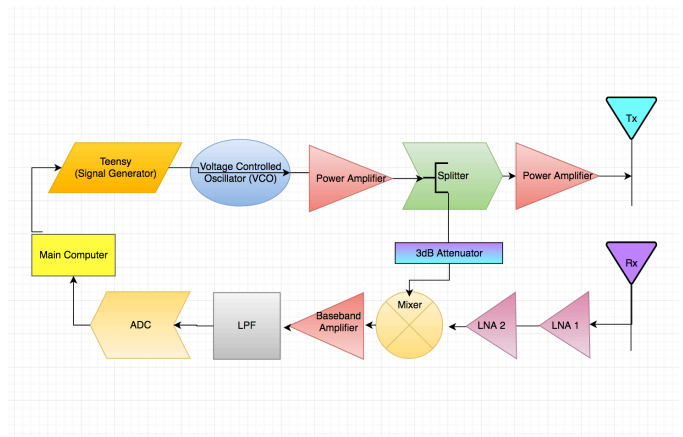

Figure 1: RADAR System Block Diagram

In the field of engineering it is useful to represent complex systems with simplified diagrams which portray many characteristics of the system. As you can see from the block diagram above, it is similar to the quarter 1 design with additional low noise amplifier to increase the strength of the received signal. We carefully chose each component with many design constraints considered. The arrows represent signal flow from transmitter, which is demodulated as the signal flows to the receiver.

In this experiment we are implementing short-range radar, which uses frequency modulated continuous waves (FMCW) for transmission and receiving. In this report, we will discuss the use of this radar technology and the objectives, details, and implementation of our RADAR detection system.

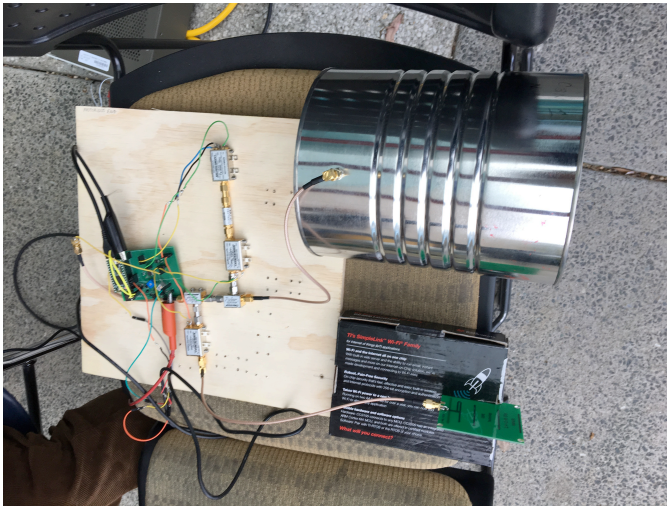

Figure 2: Team Notorious ENG Final System

II. OBJECTIVE

The main objective of this project was to apply the theory and knowledge gained in the classroom practically to a real life system. At each stage during the design process, we had to manage our time wisely, coordinate with vendors, troubleshoot, and cross-check each other's work for accuracy. We began the project process with guidance from our senior design advisor and TA's. Once we gained a good understanding, our next goal was to implement our own creative design of an FMCW radar system.

Specifically, our design specifications consist of optimal weight, power consumption, accuracy of the radar system, and stay within a \$300 budget. With each of these parameters considered, the equation which governs our overall system performance is given by,

$$\text{Score} = \frac{P_{dc} \times W}{N} \times \sum_1^N \left(\frac{|\hat{L}_i - L_i|}{L_i} \right),$$

Figure 3: Performance Score Equation

Source: Lab Manual 4 Xiaoguang "Leo" Liu

Where P_{dc} is the total power consumption, W is our system's weight, N is the number of targets, and L is the distance of the object from the Radar system. To accomplish all these goals, we carried out system design, component selection, purchasing, PCB design, PCB fabrication, Gantt chart scheduling, and assembly.

A list of the supplies used to accomplish these objectives is shown next.

III. EQUIPMENT & SUPPLIES

Quarter 1

- 1 × GSP-730 spectrum analyzer
- 2 × TPI synthesizer
- 2 × Aluminum Coffee Can
- 1 × Bench Power Supply
- 1 × Bench Oscilloscope
- 1 × Wood Board
- 1 × USB Battery Pack
- 1 × Soldering station (Solder Iron and spool of Solder)
- 2 × 12'' SMA Cables
- 4 × Male-male connector
- 1 × Electric Drill & bits
- 1 × Screwdriver
- 1 x PC Desktop Computer
- 1 x Synth Machine Synthesizer Software
- 1 x Microsoft Excel Software for MacBook
- 2 x USB cables
- 1 x Custom made SMA-wire adapter
- 1 x Function Generator from Lab 1
- 1 x Voltage Regulator from Lab 1
- 1 x Active Low Pass Filter from Lab 1
- 2 x Mini-Circuits ZX60-272LN-S+ RF Amplifiers
- 1 x Mini-Circuits ZX95-2536C+ VCO
- 1 x Mini-Circuits VAT-3+ 3dB Attenuator
- 1 x Mini-Circuits ZX10-2-42+ Power Splitter
- 1 x Mini-Circuits ZX05-43LH-S+ Mixer
- 2 x L-brackets

Quarter 2

- 1 × GSP-730 spectrum analyzer
- 2 × TPI synthesizer
- 2 × Kent Electronics 2.4GHz YAGI Antenna
- 1 x Kent Electronics 2.4 GHz Patch Antenna

- 1 × Bench Power Supply
- 1 × Bench Oscilloscope
- 1 × Cardboard Box
- 1 x Pick and Place Soldering Machine
- 2 × 12” SMA Cables
- 4 × Male-male connector
- 1 × Screwdriver
- 1 x PC Desktop Computer
- 1 x Synth Machine Synthesizer Software
- 1 x Microsoft Excel Software for MacBook
- 2 x USB cables
- 1 x Custom made SMA-wire adapter
- 1 x Teensy 3.2 Microcontroller
- 4 x Mouser MAX2750EUA+ VCO
- 4 x Mini-Circuits TAMP-272LLN+ LNA
- 4 x Mouser 581-AT0603T03ECAC7 Attenuator
- 4 x Mini-Circuits SIM-63LH+ Mixer
- 4 x Mini-Circuits SP-2U1+ Power Splitter
- 4 x NXP Semi MMG20241H Power Amplifier
- 4 x Maxim MMG20241H Low Pass Filter
- 4 x Texas Instruments TL972 Baseband Amplifier
- 4 x Linear MCP4921 DAC
- 2 x L-brackets

Component	Vendor	Model No.	Price	Datasheet	Readily Available?
VCO	Mouser	MAX2750EUA+	\$24.20 x2	https://www.mouser.co/mvds/226/MAX2750-MAX2752-69221.pdf	yes
LNA	Mini Circuits	TAMP-272LLN+	\$14.95 x2	https://www.minicircuits.com/pdfs/TAMP-272LH+.pdf	yes
Attenuator	Mouser	581-AT0603T03ECAC7	\$2.15 x4	https://www.alceramics.com/UserFiles/AT_attenuator.pdf	yes
Mixer	Mini Circuits	SIM-63LH+	\$9.65 x2	https://www.minicircuits.com/pdfs/SIM-63LH+.pdf	yes
Power Splitter	Mini Circuits	SP-2U1+	\$0.96 x2	https://www.minicircuits.com/pdfs/SP-2U1+.pdf	yes
Power Amplifier	NXP Semi	MMG20241H	\$16.92 x2	http://cache.freescopie.com/files/rf_idoc/data_sheet/MMG20241H.pdf	yes
LPF	Maxim	MAX7410	\$3.26 x2	https://www.mouser.com/mvds/226/MAX7499-MAX7414-62042.pdf	Yes https://www.digikey.com/product-detail/mxim-integrated/MAX7410CUAMAX7410CUA-R1/01513863
Antenna (Tx &/or Rx)	Kent Electronics	N/A	\$6.00 x2	https://www.ebay.com/itm/2466-30Hz-UHF-75ohm-Antenna-2-6GHz-UHF-Antenna-by-wa5vrb25333746889?hash=item33746889&si=1&from=amz1	YES
Baseband Amplifier	TI	TL972	\$0.84 x2	http://www.ti.com/lit/gs/symlink/TL972.pdf	YES
DAC	Linear	MCP4921	\$2.09 x2	https://www.digikey.com/product-detail/microchip-technology/MCP4921-E-SP/MCP4921-E-F-ND/15289	yes
Total \$			137.48		

Table 2: Final Component Choices (Price not including additional components)

Selecting components for this project was one of the most difficult tasks. We made multiple mistakes along the way, including choosing components that were not readily available, and others that were for incorrect frequency ranges. Our components list went through a multitude of drafts until we were able to secure what we thought was our finalized list. Unfortunately, we had issues with our RF board (that will be discussed in a later section) leading us to once again alter component values and reorder certain passive components. Unbeknownst to me, I discovered a vendor list Leo created toward the end of the second quarter. A link and example list is shown below.

Example Vendors:

1. Analog Devices (<http://www.analog.com>)
2. Avago Technology (http://www.avagotech.com/pages/en/rf_microwave)
3. Linear Technology (<http://www.linear.com/>)
4. Infineon (<http://www.infineon.com>)

<https://github.com/ucdart/UCD-EEC134/blob/master/support/vendors-list/vendors-list.pdf>

Finalized Funds			
Distributor	Component	Quantity	Total Cost
Mouser	VCO	4	\$65.55
	Attenuator	4	
NXP	RF Amp	4	\$17.03
Digikey	DAC	4	\$28.66
	IC Filter	4	
	Baseband Amp	4	
Mini-Circuits	LNA, Mixer, Splitter	4 each	109.92
Kent Electronics	Antenna	3	18.00
Total Thus Far = \$239.16			

Table 1: Budget broken down by distributor.

IV. PROCEDURE: QUARTER 2 WEEKLY PROGRESS

In the second quarter of our senior design project we had creative freedom to explore many options. Some of the considerations included PCB design, antenna selection, component determination, power consumption, and overall system weight. The following describes our progress each week, leading into data and results, and the conclusion.

Week 2: In the second week of Quarter 2 in our Senior Design Project, we confirmed each group member's role in the project and continued our analysis of design considerations. We also set design goals for ourselves and made a schedule of important project benchmarks.

Individual Roles

Mitchell Roberts: Signal Processing, Power Chain Calculations (ADI RF Sim), Antenna Selection

Hannah Harter: RF PCB Design & Testing, RF Component Selection, Scheduling

Jacob Gonzalez: Circuit Component Analysis, PCB & Hardware Assembly, Delegation of Tasks

Connor Bard: Baseband PCB Design & Testing, Baseband Component Selection, Soldering

Week 3: Preliminary iterations of the ADI RF Simulation were done with initial component specifications to get a feel for the simulator. Part of our team focused on component selection and power chain calculations while the other half of the team continued designing PBC's. We conducted propagation loss calculations to determine the necessary power level at the receiver. While designing the baseband PCB, we considered how many LNA's would be necessary at the receiving end to regenerate the signal. We started with one, did some cascaded gain calculations, and determined two were necessary to achieve proper signal power to reach the ADC for processing. The power chain calculation block diagram was updated to reflect propagation loss, cascaded gain, and each antenna we had on order.

Performance

- Based upon previous years
- 2nd place - design goal
- 1st place - stretch goal
- No max range component
 - Personal/team goal
- Size
 - Plan A - Stacked PCBs
 - 3"x2" and 2"x1.5"
 - Plan B - Single, larger PCB
 - 5"x1"
- Range
 - Design - ~90m
 - Stretch - 100m

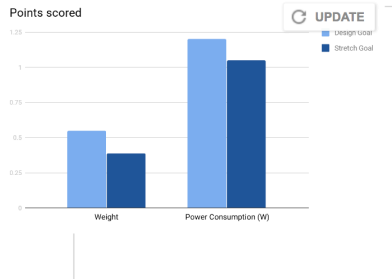

Antenna Calculations

Sigma = 0.3m x 0.3m Area Metal Plate

Path loss in dB:

$$L = 20 \log_{10} \left(\frac{4\pi d}{\lambda} \right)$$

L = Propagation Loss = -75.61 dB

Schedule

- Week 2:
- 1/18 Proposal
- Week 3:
- 1/26 Order Components
 - Begin PCB Design
- Week 4:
- 2/1 Submit PCB Designs
 - 2/1 Order Antenna
- Week 5:
- 2/9 Assemble PCBs

- Week 6
- 2/12 Functional PCBs
 - 2/14 Total System Testing
- Week 7:
- 2/23 2nd PCB Designs Submitted
 - 2/23 Possibly Select and Order 2nd Antenna
- Week 8:
- Any additional system testing
 - 3/2 Assemble 2nd PCBs
- Week 9:
- 3/9 Functional 2nd PCBs
- Week 10:
- 3/16 Total System Testing

Cascaded Gain Calculation

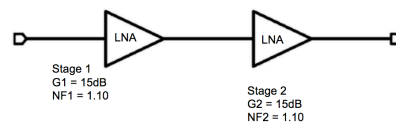

$$F = F_1 + \frac{F_2 - 1}{G_1} + \frac{F_3 - 1}{G_1 G_2} + \frac{F_4 - 1}{G_1 G_2 G_3}$$

NF_{tot} = 1.166dB
G_{tot} = G1 + G2 = 30dB

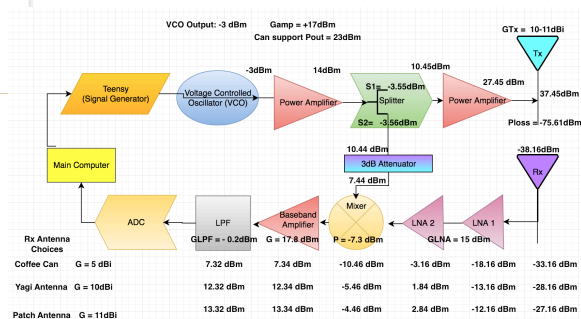

Week 5: Halfway through our project in week 5, everything was starting to come together, or so we thought. By the end of the week we had assembled PCB3, we had received our antennas, both the Yagi and Patch, we had updated our ADI Simulations, we had nailed down what we had thought was our final component list, and we had the PCBs (Baseband and RF) designed in KiCAD.

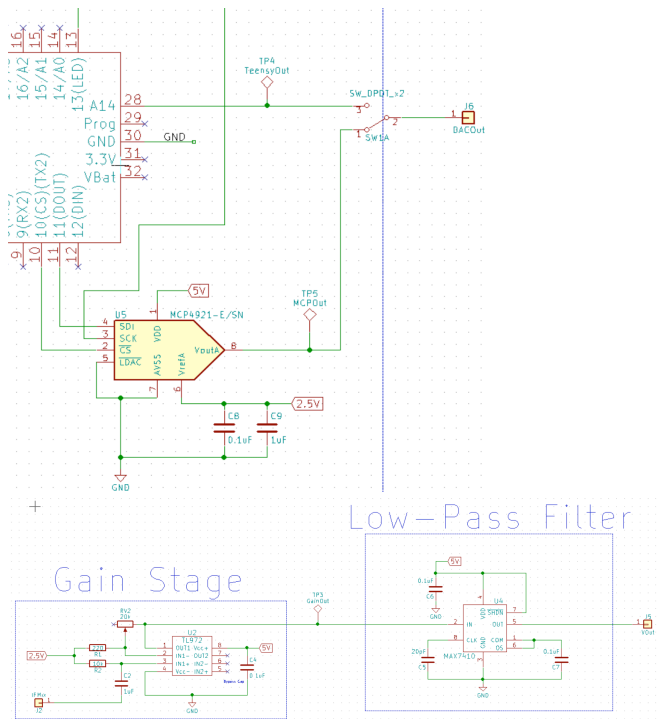
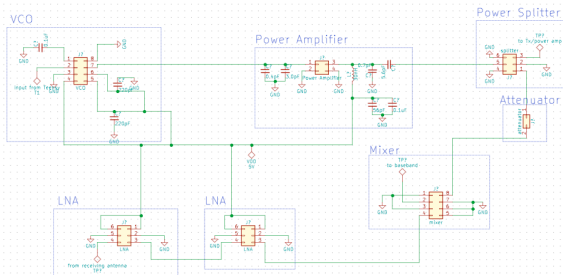

There were still footprints to be made, but this was our starting place with the PCB designs.

Week 7: By week 7, concrete moves were being made. We had ordered components, updated our budget, tested our PCB 3, Submitted both PCBs (Baseband and RF) for order, began planning system assembly, made a new schedule to be employed upon arrival of components. Below I have included the RF PCB layout followed by that of the Baseband.

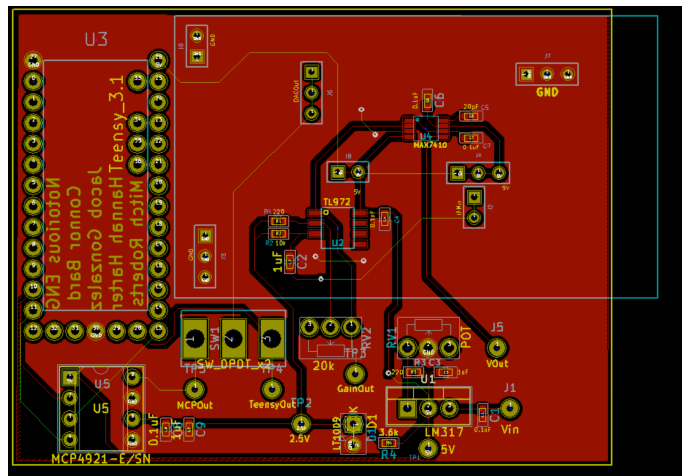
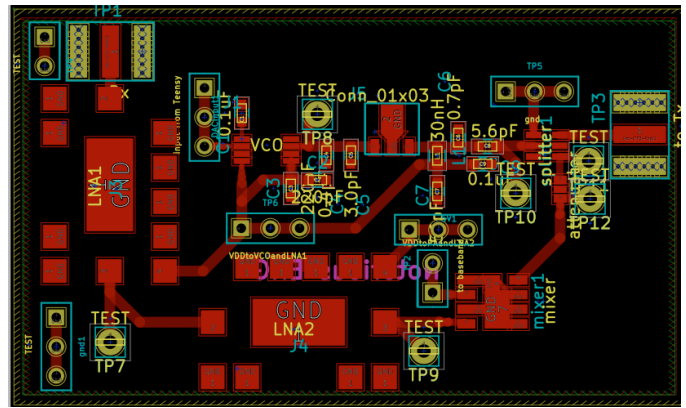

Week 8: In week 8, we were the only team who was not affected by the vendor Mini-Circuits VCO's on back order. During this time, we were waiting for our first design iteration of PCB's to return for system assembly. As a result of this, our main focus this week was to work on our quarter 1 system as a backup. During this time, we also completed some of the more administrative analysis including updated RF ADI simulation, updated budget, and an updated schedule of benchmarks to reach in the following weeks.

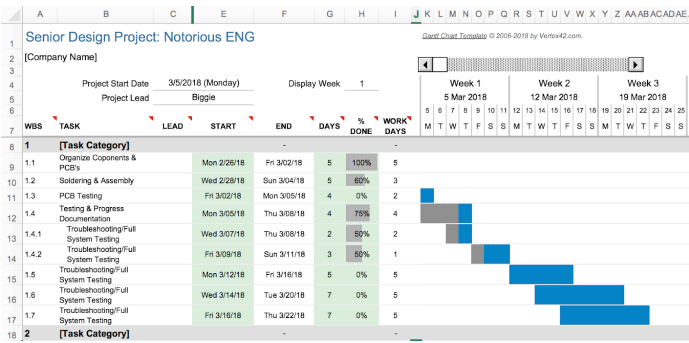

Figure 11: Updated Schedule

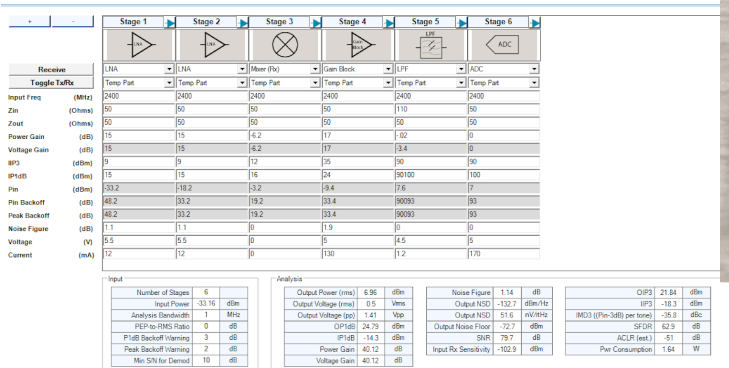

Figure 12: Receiver Signal Chain

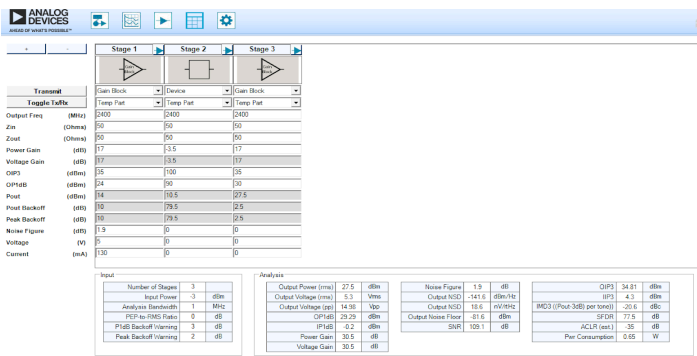

Figure 13: Transmitter Signal Chain

Week9: In week 9, we received our baseband and RF PCB's for assembly. We organized many components and soldered both PCB's using the pick and place machine. While working on assembly, we noticed that our RF PCB circuit layout was incorrect according to the correct frequency range on the data sheet. We attempted to hack our RF PCB to account for the incorrect footprints and components. We ended up redesigning our RF PCB and sending it out to be made for receipt the

following week. Along with our PCB order, we ordered additional passive components for our biasing circuitry. In the mean-time while our 2nd design iteration was being made we worked on all other aspects of the project not dependent on the RF PCB such as our quarter 1 system.

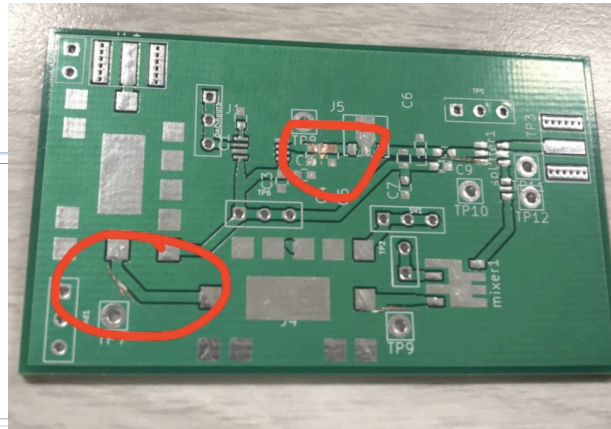

Figure 14: RF PCB Design 1st iteration

Week 10: In the final week of our senior design project we determined our RF PCB was unusable. As a result of this we ended up using our quarter 1 system RF components which weigh more. We tested our baseband PCB after assembly and determined we would use this in our quarter 1 system instead of our breadboard circuit. In addition, we spent much time downloading necessary software and libraries to test our system on our own computers outside.

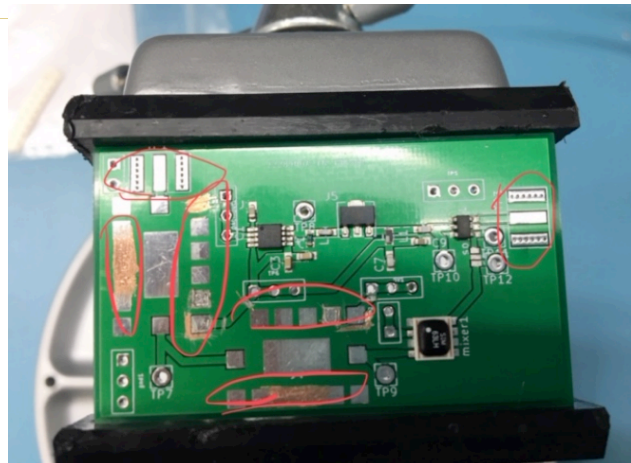

Figure 16: RF PCB 2nd Design Iteration

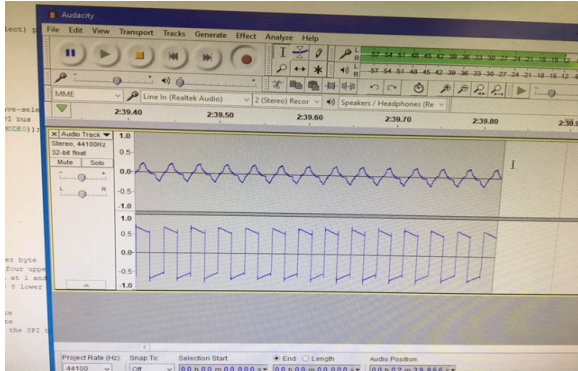

Figure 17: Audacity Output Q1 System w/ Baseband PCB

V. RESULTS, OBSERVATIONS, FIGURES & TABLES

In the competition, we ended up using our baseband PCB, the RF blocks from quarter 1, a Yagi antenna to transmit, and a coffee can to receive. On competition day, this setup weighed 0.5kg and used 1.6Watts of power. The code from quarter 1 worked well to generate a triangle wave, so we made a few minor changes (see appendix A) and used that. Although the Python code used in quarter 1 did work to produce a graph with our desired results, we decided to use similar MATLAB code because it ran faster, and we are more familiar with MATLAB than we are with Python.

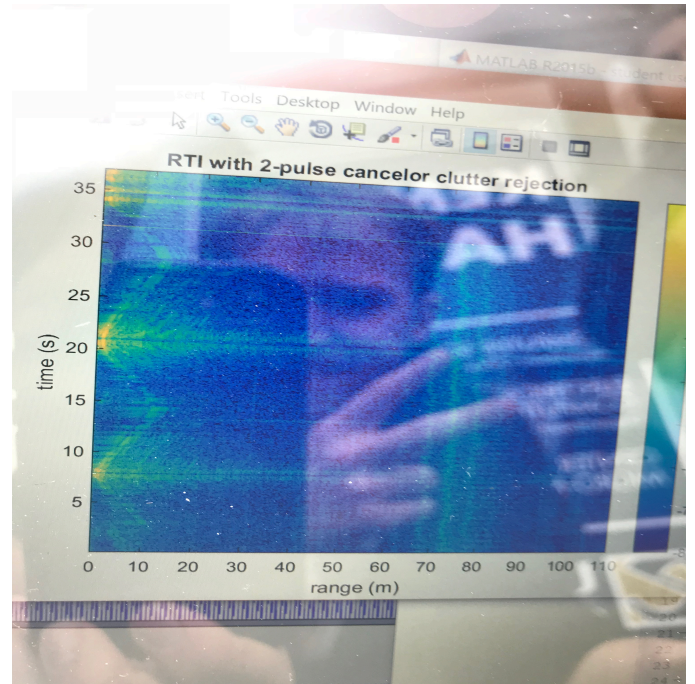

Figure 16: MATLAB Results Radar Detection (50m Range)

Actual Distance	Measured Distance
42.3672	42
33.2232	36
25.2984	28
17.0688	19
10.668	12

Table 2: Our measured results on competition day.

Calculating our score from the equation given in figure 3 resulted in an overall score of 0.3496.

VI. SOURCES OF ERROR

Within our experiment and data collected there were multiple sources of error. One main source of error is the noise that arises in the measurement devices. This is inherent to an RF system, but we tried to minimize it as much as possible. Additionally, when we were testing our system, we had a significant amount of reflection from nearby metal objects. We tried to minimize the amount of reflection we had, but in order to stay near the lab when testing, we could not avoid it.



Figure 16: Radar Setup Competition Day

VII. REFERENCES & ACKNOWLEDGMENTS

Notorious ENG benefitted a great deal from the TAs Mahmoud and Hind, who were very helpful every step of the way through the project. Also, our friend Jon and the Diode Hard -3 group, made up of Vinay, Time, Mo, and Yharo were helpful sometimes to bounce ideas off of and make sure we were getting values that were within a reasonable range. If we were having some minor trouble but Mahmoud and Hind were busy, they were useful in keeping us moving forward.

VIII. APPENDIX

The design files produced for this report consisted of the code we used to generate a 5V peak to peak triangle wave with a period of 40ms, and the code we used to generate a graph of distance vs. time. The triangle code can be found in Appendix A and the graphing code can be found in Appendix B

Appendix A

```
/*
Triangle wave and sync pulse generator to control a (0-5V input range) VCO for FMCW radar.
The MPC4921 DAC is used to generate a triangle wave with a period of 40ms.
PWM of the Arduino UNO is use to simultaneously generate the sync pulse,
used for signal processing.
*/

#include <SPI.h> // Include the SPI library

word outputValue = 4; // A word is a 16-bit number
int incr = 1;

const int slaveSelectPin = 10; //set the slave select (chip select) pin number
const int SYNC = 8; //set the SYNC output pin number

void setup()
{
  // Set pins for output
  pinMode(SYNC, OUTPUT); // SYNC pin
  digitalWrite(SYNC, LOW); // Sync pulse low
  pinMode(slaveSelectPin, OUTPUT); // Slave-select (SS) pin
  SPI.begin(); // Activate the SPI bus
  SPI.beginTransaction(SPI_Settings(16000000, MSBFIRST, SPI_MODE0)); // Set up the SPI transaction;
  this is not very elegant as there is never a close transaction action.
}

void loop()
{
  if (outputValue == 4092 || outputValue == 0){
    incr = -incr;
  }
}
```



```

    digitalWrite(SYNC, !digitalRead(SYNC));
}

outputValue = outputValue + incr;

byte HighByte =highByte(outputValue); // Take the upper byte
HighByte = 0b00001111 & HighByte;    // Shift in the four upper bits (12 bit total)
HighByte = 0b00010000 | HighByte;    // Keep the Gain at 1 and the Shutdown(active low) pin off
byte LowByte = lowByte(outputValue);  // Shift in the 8 lower bits

digitalWrite(slaveSelectPin, LOW);
SPI.transfer(HighByte);                // Send the upper byte
SPI.transfer(LowByte);                 // Send the lower byte
digitalWrite(slaveSelectPin, HIGH);    // Turn off the SPI transmission
}

```

Appendix B

Matlab Code used to Process our Radar Range Signal and Determine the Range.

%MIT IAP Radar Course 20112.5

%Resource: Build a Small Radar System Capable of Sensing Range, Doppler,

%and Synthetic Aperture Radar Imaging

%

%Gregory L. Charvat

%Process Range vs. Time Intensity (RTI) plot

clear all;

close all;

% read the raw data .wav file here

% replace with your own .wav file

[Y,FS,NBITS] = wavread('running_outside_20ms.wav');

%constants

c = 3E8; %(m/s) speed of light

%radar parameters

Tp = 20E-3; %(s) pulse time

N = Tp*FS; %# of samples per pulse

fstart = 2260E6; %(Hz) LFM start frequency

```

fstop = 2590E6; %(Hz) LFM stop frequency
BW = fstop-fstart; %(Hz) transmit bandwidth
f = linspace(fstart, fstop, N/2); %instantaneous transmit frequency

%range resolution
rr = c/(2*BW);
max_range = rr*N/2;

%the input appears to be inverted
trig = -1*Y(:,1);
s = -1*Y(:,2);
clear Y;

%parse the data here by triggering off rising edge of sync pulse
count = 0;
thresh = 0;
start = (trig > thresh);
for ii = 100:(size(start,1)-N)
if start(ii) == 1 & mean(start(ii-11:ii-1)) == 0
%start2(ii) = 1;
count = count + 1;
sif(count,:) = s(ii:ii+N-1);
time(count) = ii*1/FS;
end
end

%check to see if triggering works
% plot(trig,'b');
% hold on;si
% plot(start2,'r');
% hold off;
% grid on;

%subtract the average
ave = mean(sif,1);

```

```

for ii = 1:size(sif,1);
sif(ii,:) = sif(ii,:) - ave;
end

zpad = 8*N/2;

%RTI plot
figure(10);
v = dbv(iff(sif,zpad,2));
S = v(:,1:size(v,2)/2);
m = max(max(v));
imagesc(linspace(0,max_range,zpad),time,S-m,[-80, 0]);
colorbar;
ylabel('time (s)');
xlabel('range (m)');
title('RTI without clutter rejection');

%2 pulse cancelor RTI plot
figure(20);
sif2 = sif(2:size(sif,1),:)-sif(1:size(sif,1)-1,:);
v = ifft(sif2,zpad,2);
S=v;
R = linspace(0,max_range,zpad);
for ii = 1:size(S,1)
%S(ii,:) = S(ii,:).*R.^(3/2); %Optional: magnitude scale to range
end
S = dbv(S(:,1:size(v,2)/2));
m = max(max(S));
imagesc(R,time,S-m,[-80, 0]);
colorbar;
ylabel('time (s)');
xlabel('range (m)');
title('RTI with 2-pulse cancelor clutter rejection');

```

